

3D Virtual and Physical Simulation of Automated Container Terminal and Analysis of Impact on In Land Transportation

**Behrokh Khoshnevis
Ardavan Asef-Vaziri
University of Southern California**

December 2000



Abstract

The purpose of this research is to analyze the impact of instituting Automated Storage and Retrieval Systems (AS/RS) on the operations of a prototype maritime container terminal. A 3D simulation model is developed to measure the effectiveness of the proposed total system and compare it with existing practices. Three performance analysis variables are defined for this comparison. These key-variables are (1) throughput, (2) space utilization, and (3) horizontal material handling equipment utilization. The basic model is generic in nature, however, its details are on the basis of a prototype terminal in the combined ports of LB and LA.

1. Introduction

Material handling process re-engineering is now a critical issue for logistics and supply chain managers of airlines, shipping lines, terminal and warehousing enterprises around the world.. While creating place and time utility, material handling is considered as a non-value-added activity. Distance and time of material handling, times of re-handling, and the amount of Work In handling Process (WIhP) play a substantial role in the final cost of goods. Estimates of up to 50% of the cost of goods are attributed to material handling and logistics [5]. Maritime container terminals are now faced with higher volume of traffic, limited land, larger vessel sizes, and lower profit margins.

More goods and products are shipped through the Port of Long Beach than any other port in the United States, while the Port of Los Angeles ranks second. Collectively, the two ports together make up the third largest in the world. The Port of Long Beach had close to 100 billion in trade in 1998, and is experiencing a 15% per year increase in activities.

It is believed that the current container handling processes result in misallocation of expensive and scarce land in maritime sites, waste of capital in inventory, long waiting time of road- trucks and ships, and a larger fleet size of yard-trucks.

Recently, the term Automated Guided Vehicle Systems (AGVS) has become a keyword in publications and conferences addressing horizontal handling of containers in maritime terminals. The European Container Terminal (ECT) in Rotterdam, the Netherlands is the most automated container terminal in the world. A fleet of AGVs integrates yard-cranes and ship-cranes. Ports of PSA (Singapore), Kaoshiung (Taiwan), Pusan (Korea), Kawasaki (Japan), Kajima (Japan), Thamesport (UK), Bremerhafen (Germany), Hamburg (Germany), and Antwerp (Belgium) have all announced plans to implement AGVS. The PSA is foreseeing to implement a fleet of up to 2,000 AGVs.

The fact that maritime terminals are attracted to AGVS was the main motivation of this search to study the feasibility of implementing AS/RS for storage and retrieval in intermodal containers. The Material Handling Industry of America defines the AS/RS as a storage system that uses fixed-path storage and a retrieval machine running on one or more rails between fixed arrays of storage racks. Limited space, high labor costs, shorter cycle times as well as reliability in cycle time, random access requirements, sensitivity to

accuracy in order deliveries are all motivates of AS/RS implementation. The number of systems installed in the US is in the hundreds and installations are increasing. Unit loads weight from an envelop to more than 100,000 pounds.

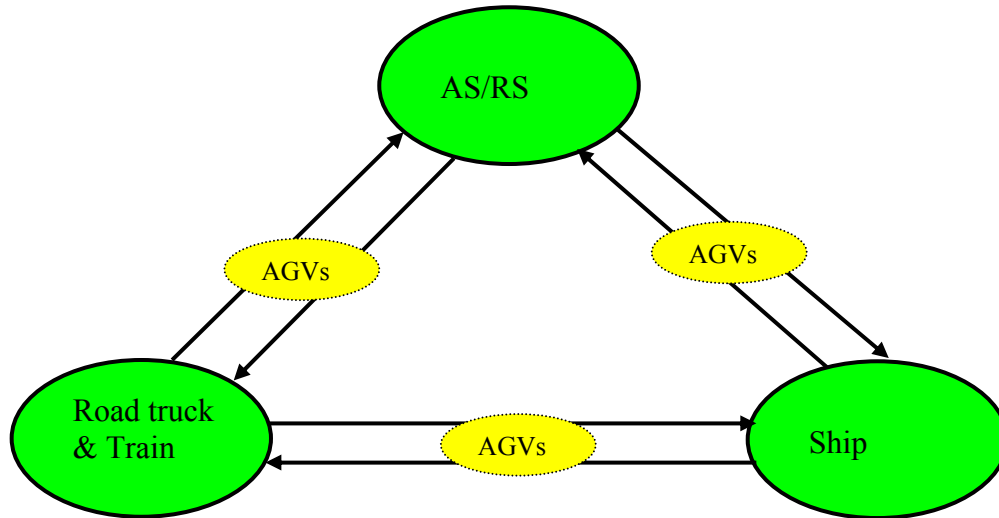

Figure 1. AS/RS and AGVS integration in container terminal

2. Current Practices

2.1 Process Analysis

The function of a prototype maritime terminal is to receive, store, and retrieve intermodal containers. The term intermodal roots from the fact that the containers can be transshipped from one mode of transportation (ship, truck, and train) to another. Intermodal containers are made of steel or aluminum. They are 8 feet in width, 8.5 feet in height, commonly either 20 or 40 feet in length, and can weigh up to 100,000 pounds. Container movement and storage is measured in TEU's (Twenty-foot Equivalent Units). Since in this paper we only deal with forty feet containers, the abbreviation of FEUs is implemented to refer to forty feet containers.

Containers arriving by sea are removed from ships by massive quay cranes that typically place the containers on yard-trucks. Yard-trucks travel on bi-directional networks connecting road-truck sites, stacking storage area, and ship load/unload site. On the average, an inventory of more than two weeks of activities is stored on a yard. Forty feet containers are commonly stored in blocks of length of 10, width of 6, and height of 3 containers. Each block is equipped with a gantry crane. Two conventional alternatives for gantry crane are bridge crane and straddle truck. An individual container can be stored in

any location of any block in the yard. Gantry cranes have to dig-out the containers in the lower levels. On the average, a gantry crane could furnish 18 FEU moves per hour.

A typical stacking storage yard is a rectangle of 520 by 1400 feet having 18 blocks of containers. [Taken from a concept by Jordan-Woodman-Dobson in Norfolk International Terminal (NIT).] While this area is assigned to containers of 3 ships, it serves one ship at a time. On the average, a fleet of 25 yard-trucks is required to achieve around 100 round trips per hour from receiving to block storage site to shipping and back to receiving. Shipping and receiving play interchanging roles. The truck receiving site in turn is shipping, the ship site is shipping for incoming containers and receiving for outgoing.

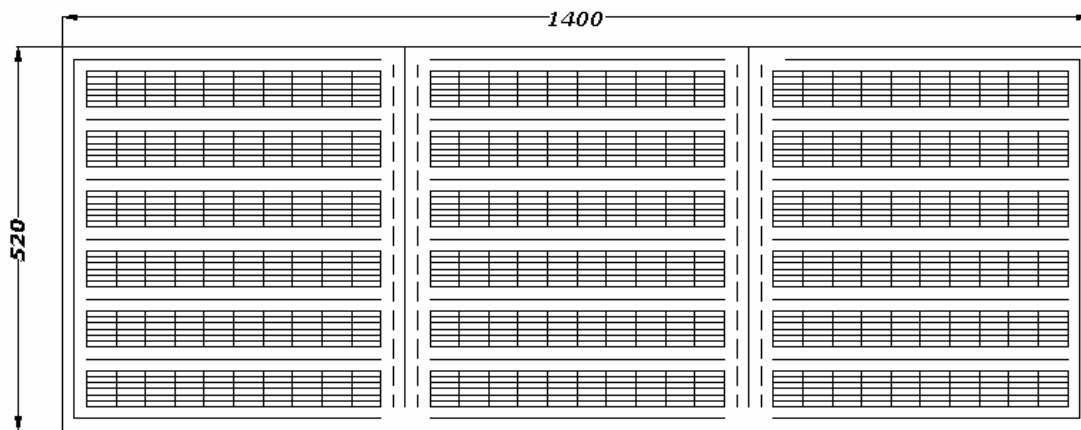

Figure 2. A prototype of containers block storage at maritime terminals.

2.2 Performance assessment

The key-variables for performance assessment of this system are summarized below

- 1-Throughput.
- 2-Space Utilization.
- 3-Horizontal material handling equipment utilization.

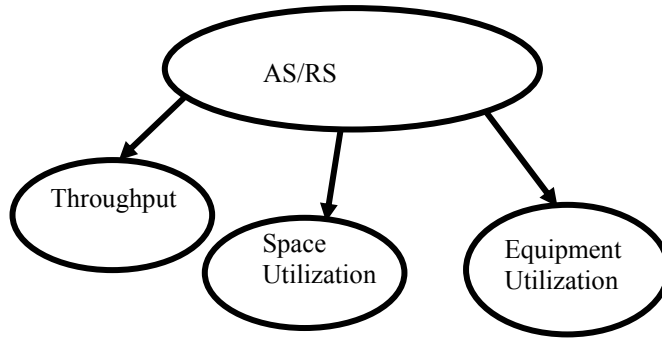

Figure 3. Key-variables for performance evaluation

A. Space Utilization

- 1- Gross area assigned per block of containers $(520)(1400)/18 = 40000$
- 2- FEUs stored per block = $(10)(6)(3) = 180$
- 3- FEUs stored per 10000 square feet $(180/40000) 10000 = 45$

Note that the actual space utilization indices are lower than the above figures. Indeed, in order to reduce digging of gantry cranes, as soon as an outgoing container of a specific ship is located in a block, the next two levels of that location are reserved for containers of the same ship. Therefore, on the average much less than 178 FEUs are stored per 10000 square feet. The situation gets worse when a block fraction (a portion of a block or a whole block) is assigned to outgoing containers of a specific ship as soon as its first container arrives. As the remaining containers arrive over a two-week period, they are placed in the allocated block fraction. Once the vessel arrives, the containers are removed from the block and are loaded in the ship. The block fraction is then assigned to a new ship [4].

B. Throughput

- Gantry crane moves per hour per 100 FEUs stored $(18/180)100 = 10$
 Gantry crane moves per hour per 10000 square feet = 4.6

C. Truck utilization

- Horizontal round trips per hour per yard-truck $100/25 = 4$

Moves of the gantry crane are combinations of Single Command (SC) and Double Command (DC) moves. A DC move is to pick-up a container from a yard-truck, store it in a location in the block, pick-up another container from another location in the block, and deliver it to the yard truck. A single command move accomplishes either a store or a retrieve between successive visits to yard-truck. Horizontal moves are also combination of double and single command moves. A double command move of a yard-truck is a loaded round trip from ship site (or truck site) to storage site, and back to ship site (or truck site). In a single command move, one way of the round trip is empty.

3. Elements of an AS/RS

An AS/RS has four major components: *storage racks, storage and retrieval machine (SRM), the shuttle, the planning and control system*. A horizontal material handling equipment is also required as the interface between AS/RS and other systems..

Rack Structure An AS/RS rack structure is composed of a set of columns referred to as bays and a set of rows referred to as tiers. Commonly, all bays have the same width, bays in the same tier have the same height. The intersection of bays and tiers are referred to as cells. A typical AS/RS structure module consists of single-deep stored unit loads in two parallel long narrow racks and an aisle between them. Storage racks interface with the storage and retrieval machine and require very tight tolerances. The guide rails installed in the aisle must allow the to move in and out freely and stop exactly at the desired cell or pick-up and delivery (P/D) station(s). Typically a P/D station is located at one end on the lowest level of each rack, such a configuration is referred to as end of aisle order picking.

There are at least two well-known variations in the above prototype configuration. One variation is to store loads in more than single-deep racks. This is beneficial if the throughput requirement is moderate, and there are considerable numbers of containers being assumed identical with respect to some attributes. For example, outbound containers going into a specific hatch of a specific ship are all identical with respect to the precedence of loading into the ship. Out-bound containers could satisfy this condition, however, in-bound containers do not fully fit into such requirement.

A second variation in a prototype AS/RS is to have multiple P/D stations located at both ends as well as at some middle points of the racks. This is beneficial to separate the inbound and outbound loads, increases the throughput, and increases the efficiency of the horizontal material handling system.

Storage and retrieval machine (SRM): The SRM moves simultaneously in both horizontal and vertical directions. It moves along floor-mounted rails parallel to the storage racks for horizontal trips, and along a mast for the vertical part of the trip. The SRM picks up a load from the P/D station (or from a storage cell), delivers the load to an empty cell (or to P/D station), sets the load down, and returns empty to the P/D station (or a loaded cell). Such a trip is referred to as Single Command (SC). It accomplishes either a store or a retrieve between successive visits to the P/D station. In a double command (DC) trip, the SRM picks up a load at P/D stand, travels loaded to an empty location, sets down the load in the empty location, travels empty to a loaded cell in the rack, picks up the load, travels loaded to the P/D station, and sets down the load on the P/D station.

The Shuttle: The SRM moves in X and Y directions, the shuttle moves in Z direction. Pick-up and delivery in storage cells and P/D stands are accomplished via a specially designed shuttle mounted on the SRM. When the SRM is fine positioned both in horizontal and vertical direction with the cell or the P/D stand, the shuttle starts a move in the direction perpendicular to the movement plane of SRM.

Planning and Control System Containers arrive on a random basis. As soon as a P/D station becomes empty a container is delivered to it, then the SRM moves the load to an empty location in the rack. Pick-up and delivery on both P/D stations and storage cells are automated and are controlled by a computer. Request for retrieval of items also follows a random nature, with more randomness for trucks than for ships and trains. When these incoming and outgoing randomness are combined with material storage policies, an additional stochastic factor, which is the location of items in the rack is introduced. The location assignment and planning, tracking, and control of the total system are accomplished through a distributed system.

4. AS/RS Systems for Maritime Terminals

There are four preliminary concepts developed for implementing AS/RS in maritime container terminals, as presented below.

Earl's as a leading manufacturer of container spreader bars, has built a full-scale prototype of an AS/RS called Computainer, Figure 1(a). It is a multistory steel structure with a small number of storage cells. Multiple access bays are provided for rapid truck turn around. According to Earl's, an integrated hoist transfer system with straightforward mechanical design and operational simplicity endures on time performance and long term dependability.

Krupp as a German manufacturer of marine cranes and mining material handling equipment has developed a concept called Fast Handling System, Figure 1(b). A small prototype of this concept has been installed in Duisburg-Rheinhausen terminal. Each module of this system incorporates a set of end and middle P/D stands, a high-rack handling device, and a channeling vehicles. The high-rack handling device moves along the transverse aisle on running and guide rails. It consists of a lifting frame, lifting crossbeam, turning device and channeling vehicles. The high-rack handling device mainly serves to transport the loading units vertically to the storage.

Tansact-Seaport has adopted a proprietary design of double deep racks where each rack consists of 13 bays and 10 tiers, Figure 1(c). The roof plays the role of an empty tier for shuffling of double deep bays. Bays are either 44 or 22 feet wide and 12 feet high. An automatic stacker crane called Elevating Transfer Vehicle (ETV) interfaces horizontally and vertically with the storage cells. A shuttle mounted on the ETV stores and retrieves the containers from the storage cells. An automatic overhead crane with a 40-foot spreader provides the means to receive and deliver containers to and from the horizontal material handling system (transfer cars). The crane is located at the front and middle of the external wall.

The USC Concept, developed by professor Behrokh Khoshnevis is an integrated concept containing AS/RS, incoming trucks, and a set of automated shuttles (see Figure 4). The containers are transferred from AS/RS stand to a turn table with its rails in the direction of AS/RS modules. The turn table then rotates by 90 degrees and matches with the direction of shuttle rails. Containers are then moved to the ship by the shuttles.

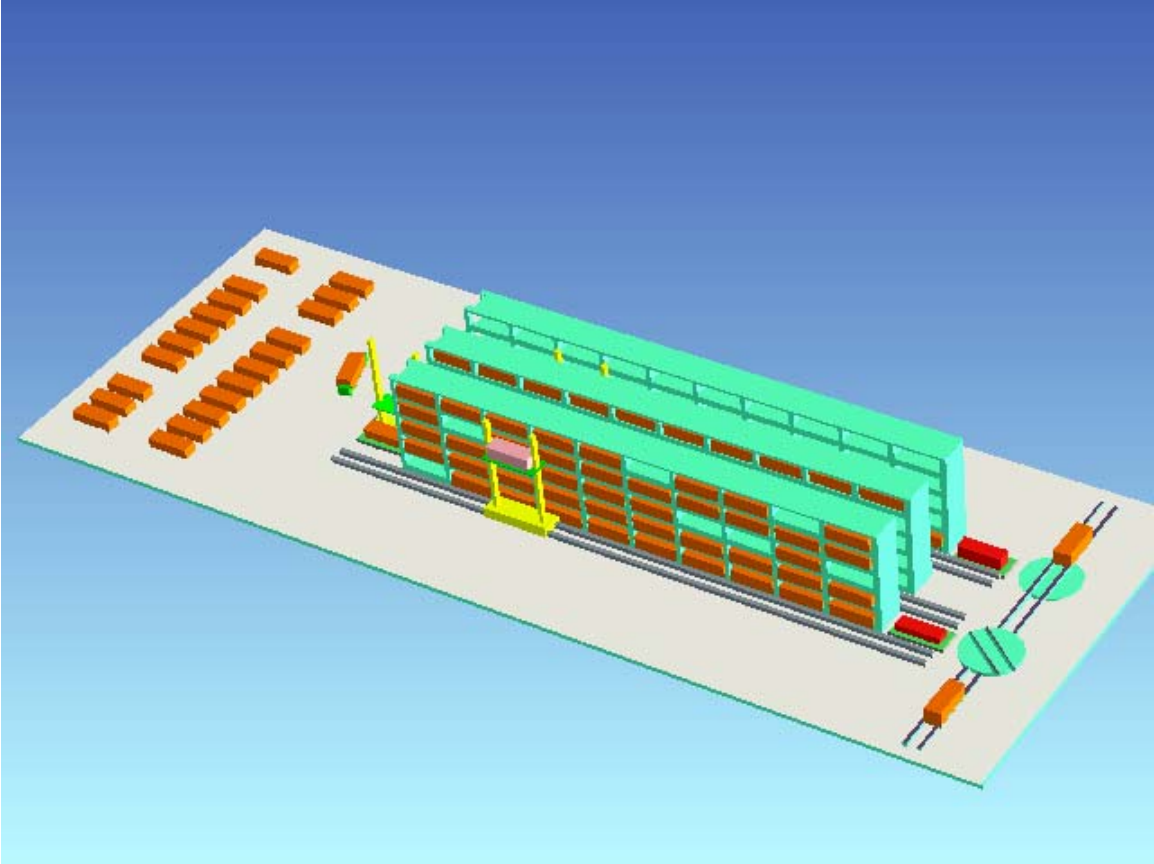

Figure 4. A prototype of containers block storage at maritime terminals.

5. Automated Guided Vehicle Systems (AGVS)

A horizontal material handling system is the interface between AS/RS and ship cranes on one hand, and between AS/RS and truck and train docks on the other hand. In current practice different types of manual trucks, hostlers, straddle trucks, etc. are used as the mode of horizontal material handling. Recently the term “AGVS” has become a keyword in publications and conferences addressing horizontal handling of containers in marine port terminals.

Automated Guided Vehicles (AGVs) are driverless, automatically controlled, capable of loading, transporting, and unloading without human intervention. They perform all kinds of tasks from mail deliveries to transportation of 300000 lbs loads. AGVs move along a guide-paths which can be modified easily. The first AGV was built in 1953. It was a modified towing tractor used to pull trailers and followed an overhead wire in a grocery warehouse. In 1973 Volvo in Kalmar, Sweden implemented 280 AGVs in its assembly line. The unit load AGV was introduced in mid 70s and gained widespread acceptance in material handling industry. As electronics and microprocessors advanced, so did AGVS. Today, there are more than 15 types of vehicles and 40 worldwide manufactures.

Integration of AS/RS and AGVS can achieve maximum flexibility and rapid real-time response. Benefits of AGVS include low operating costs, reduced maintenance, excellent vehicle availability, safety, and environmentally clean operations. This concept is illustrated in Figure 4.

5.1 AGVS in Port Operations

The European Container Terminal (ECT) in Rotterdam, the Netherlands is the most advanced container terminal in the world. A fleet of AGVs (Figure 3 top left) integrates Yard-cranes (top right) and ship-cranes (bottom). A team of Frog Navigation and Mannesman Demag Gottewald GmbH of Germany delivered a fleet of more than 100 AGVs in the course of 6 years at ECT. The system is successful but it has been a slow course of success. Other ports considering this technology are watchful of ECT's success but they recognize it has been a slow road. In this period, there have been substantial improvement in speed of vehicles, as well as in the navigation technology and communications systems.



Figure 5. Three major entities of container handling system at European Container Terminal

Ports of PSA (Singapore), Kaoshiung (Taiwan), Pusan (Korea), Kawasaki (Japan), Kajima (Japan), Thamesport (UK), Bremerhafen (Germany), Hamburg (Germany), and Antwerp (Belgium) have all announced plans to study or to implement AGVS. The PSA is foreseeing to implement a fleet of 1,000 to 2,000 AGVs.

5.2 AGVS Manufacturers

There appears to be a division of suppliers for this technology. Some companies are focused on the mechanical design and others on the navigation technology. Companies that offer the Navigation solutions include: Frog Navigation (US and Netherlands), Tadiran, Automatic Port System (Israel), DSO National Laboratories and CET Technologies Pte Ltd (Singapore) . Frog Navigation clearly has the most experience in outdoor navigation. They have used wire guidance, free-ranging transponders, and DGPS successfully.

Mitsui Engineering & Shipbuilding (MES) (Japan) and Kamag (Germany) have sold prototype vehicles to the PSA. The guidance was provided under a joint-venture relationship between Tadiran and Singapore Technology Ventures. The vehicles appeared mechanically sound but it was said there were navigation and traffic issues that needed to be resolved. Terberg Benschop (Netherlands) sold 2 prototypes to Thamesport with guidance by a company called Firefly. It was a radar based navigation system that required more funding for development. Firefly eventually closed their doors but the radar technology is still a potential guidance solution. Schueulre (Germany), and Mentor AGVS (United States) are other potential AGV manufacturers for port implementation.

If this industry takes off look for other large systems integrators and crane builders to enter the market. Raytheon (USA), Samsung Heavy Industries (Korea), Noell (Germany) and Kalmar (Sweden) are all potential suppliers of AGV system equipment. Linking with the right partner for successful navigation will be one of the keys to success.

The vehicle mechanical designs are equally important and can be quite complex. The Kamag units at the PSA have complex hydraulic suspensions, drive and steering systems allowing the vehicles to travel sideways. Mentor AGVS based in Cleveland, USA ,has manufactured a several axled AGVs that share similar characteristics to port AGVs. Mentor AGVS in partnership with Ottawa Truck believe that converting existing port tractor designs is the lowest cost venue for implementing a AGVS in container terminals.

Based on information gathered from the above sources, implementation of AGVS in marine port terminals result in potentially 80 percent reduction in labor, 50 percent reduction in maintenance, and 10 percent reduction in energy costs

6. A Hypothetical Configuration

In this section we present a hypothetical configuration for implementing AS/RS and AGVS in marine port container terminals.

6.1 Rack Structures

In our conceptual design each rack consists of 10 bays and 10 tiers. Cells are single deep and are designed for 40' containers. Each cell has a width of 42', a height of 11', and a

depth of 10'. Each aisle is 9' wide, and a P/D stand is located at the end of aisle. The net dimensions of each module are length of 462 feet [(10)(42)+42], width of 29 feet [(2)(10)+9], and height of 101 feet [(10-1)(11)+2]. The total net area required for each module is less than 14000 square feet while it can store 200 FEUs. Given such a system, the space utilization key variables are measured as follows:

- ❑ Gross area assigned per AS/RS module: 14000 sqft
- ❑ FEUs stored per module: 200
- ❑ FEUs stored per 10000 square feet: 142

No actual cost data is available. The rough-cut cost estimate is around 2.5 million dollars for each module.

6.2 Storage and Retrieval Machine

A machine of approximately 80' high and designed to handle loads of 40000 lbs. would likely to have a dead weight of approximately 150,000 lbs. Including the live load, the total load could approach 200,000 lbs. Although both horizontal and vertical trips of SRM are accomplished simultaneously, the actual trip time is determined by the longer trip. The typical velocity profiles for elements of SRM *normal* and *short* trips (for both horizontal and vertical trips) are shown in Figure 6. Table I presents estimates of various speeds.

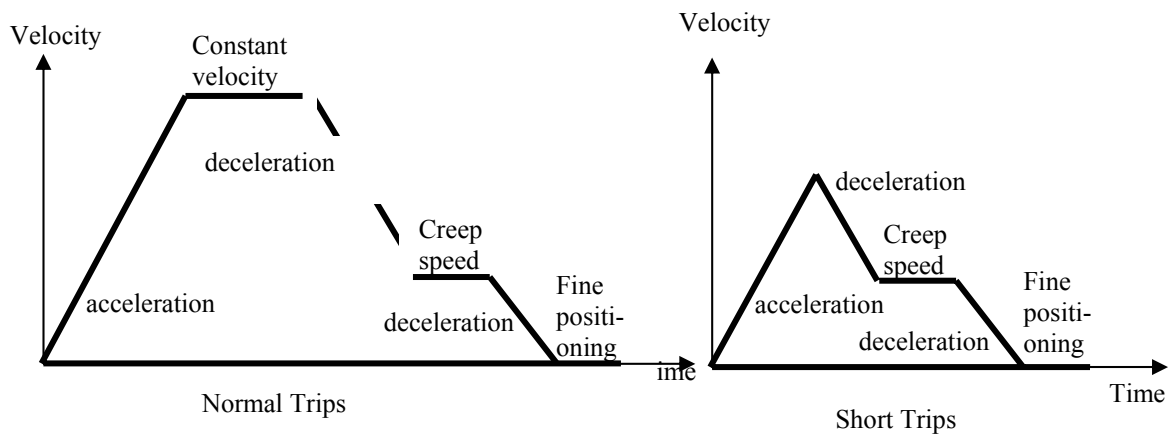

Figure 6. Characteristics of normal and short SRM trips in either horizontal or vertical movements.

Table I. Estimates of various velocities of ASRS machine

Movement	Horizontal		Vertical	
	Optimistic	Pessimistic	Optimistic	Pessimistic
Loaded velocity (Ft / Min)	600	300	150	75
Empty velocity (Ft / Min)	700	700	175	90
Acceleration (Ft / Sec ²)	3	1	1	.4
Deceleration (Ft / Sec ²)	3	1	1	.4
Creep speed (Ft / Min)	300	150	50	25

Creep distance (Ft)	0	10	0	3
Fine positioning (Sec)	0	5	0	2

6.3 The Shuttle

The shuttle is very similar to a 3-section telescope, and is consist of a base, an intermediate, and a top slide. The base is fixed to the vertical carriage of the SRM. The intermediate slide extends by half of its width. The top slide is capable of extending one load width to either side of the aisle. A simple representation is given in Figure 6. A shuttle cycle consists of a shuttle extend, pause, lower (rise), shuttle retract to center, pause. The pause time allows for setting of the machinery and control reaction time.

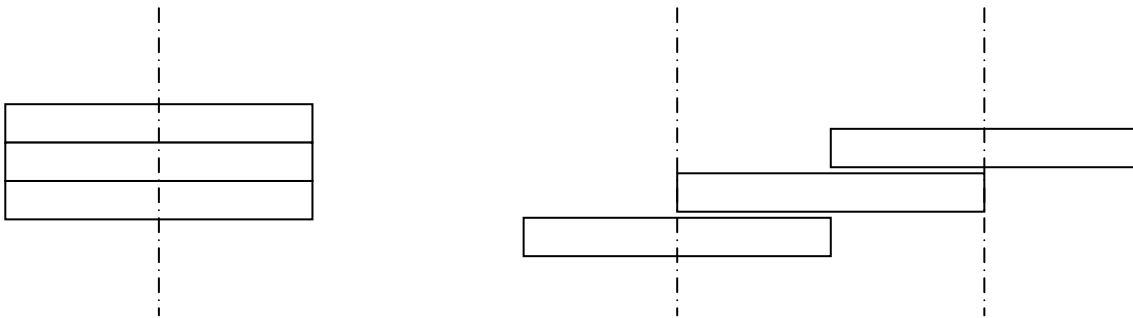

Figure 7 A simplified representation of shuttle movement

Assuming the container is carried with the long axis (40') down aisle, and extend out 9' to deposit the container in the rack, a shuttle cycle time of less than 20 seconds is expected. The cycle time will be longer if the container is deposit along the 40' axis. Turning the load 90 degrees so that the long axis is cross aisle and extending 41' into the racks increases the set down time to 30 seconds. The range of 15 to 30 seconds were examined for shuttle pick up and set down time in the simulation model.

The total cost of AS/RS machine and its mounted shuttle is estimated around 1.5 million dollars.

6.4 The horizontal material handling system

AGVS is implemented as the mode of horizontal material handling. Our estimates of the velocity specifications of AGVs are as follows.

- Loaded and empty velocity 100 and 150 Ft / Min respectively.
- Acceleration and deceleration both 1 Ft / Sec².
- Pick-up and set down time each 15 seconds.

7. The Simulation Model

AutoMod [2] was used to simulate the concept. A view of the yard layout and the simulation model is shown in Figure 6. The throughput of an AS/RS module under a relatively optimistic scenario is 45 single command and 33 double command moves per

hour. To make it comparable with gantry crane moves we assume an average combined performance of 39 moves per hour.

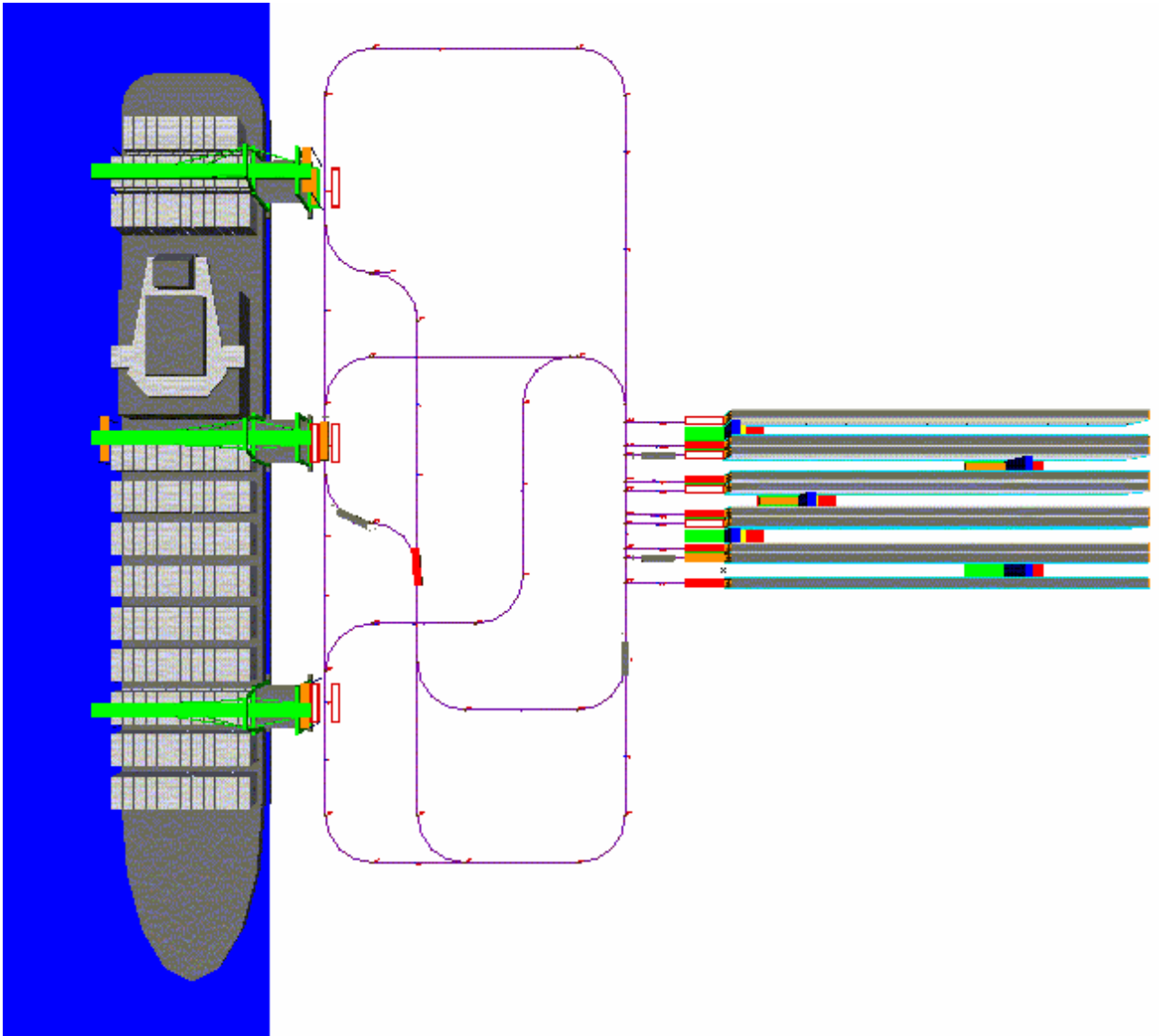

Figure8. A view of the yard layout and the simulation model.

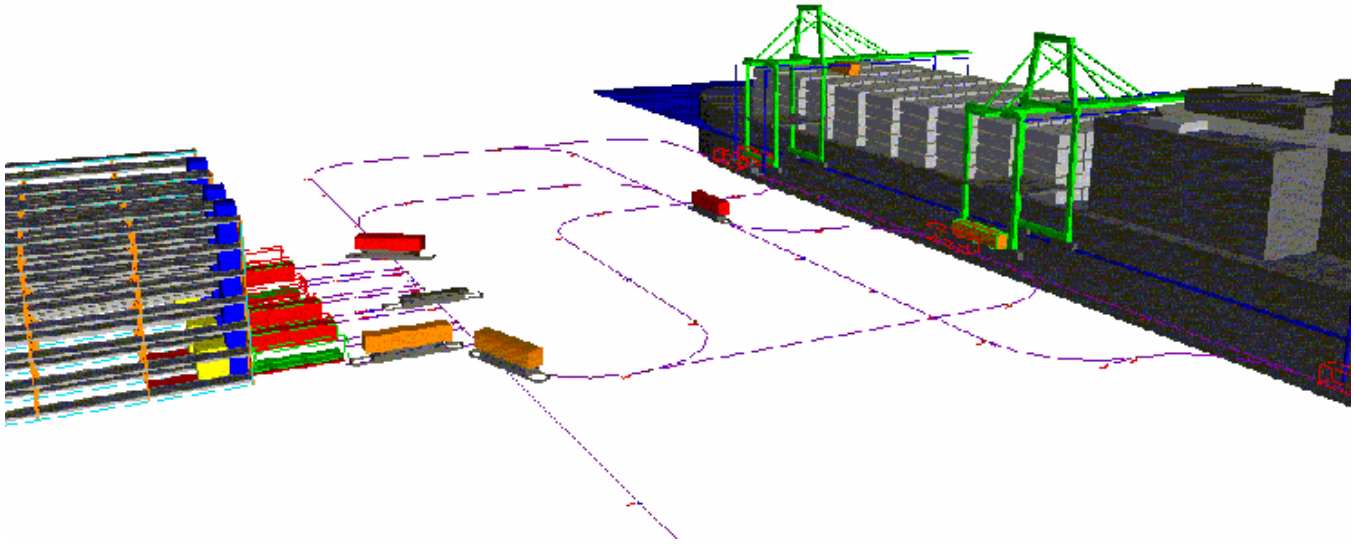

Figure 9. A view of the yard layout and the simulation model

Figure 10-(a) is a single-variable sensitivity analysis graph. It represents the impact of a percentage increase in one specific parameter on the throughput of the system. As the graph shows, the horizontal and vertical velocity of the crane is the most sensitive factor. The design parameters of the crane velocity should be reviewed carefully. On the other hand, acceleration and deceleration speed is not a very sensitive parameter. Note that in the double command moves, the pick up and set down speed of the shuttle becomes the most sensitive factor. This is due to the fact that there are two pick up and two set down in double command moves.

Figure 10-(b) is a double -variable sensitivity analysis graph. It shows the impact of the simultaneous change in loading / unloading time and horizontal / vertical velocity over the throughput.

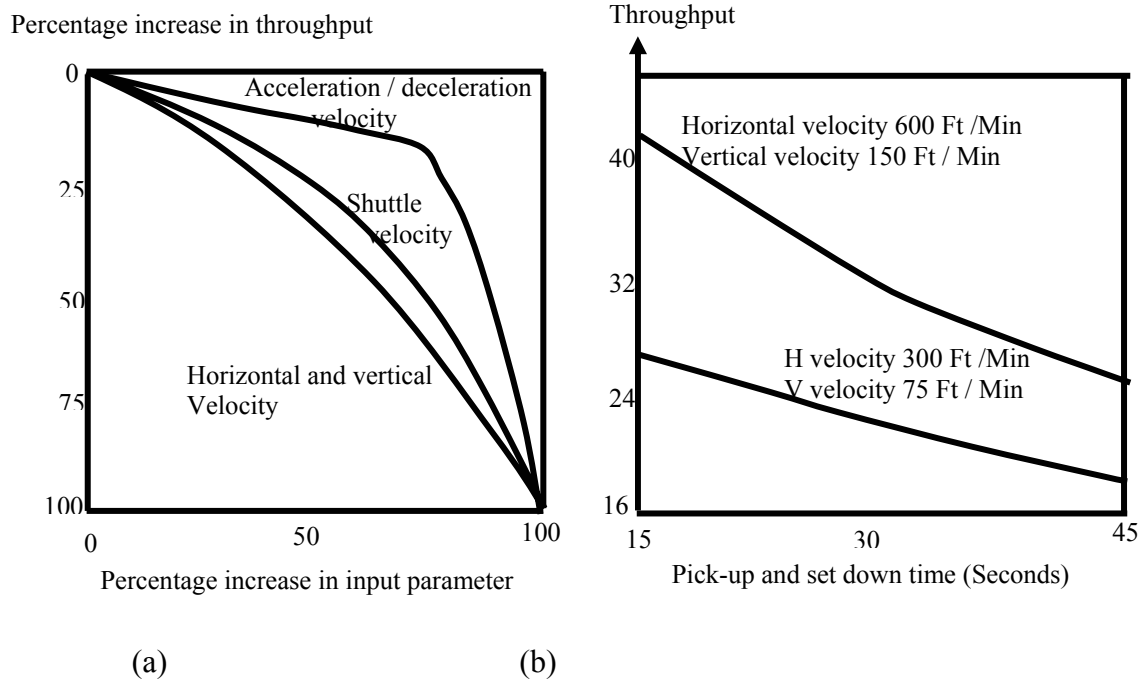

Figure 10. Sensitivity analysis on major input data of the simulation model

Throughput:

1. Moves per hour per 100 FEUs stored $(39/200)100 = 19.5$
2. Moves per hour per 10000 square feet $= (39/14000)10000=27$

AGVs Utilization:

Horizontal round trips per hour per AGV $(39/3) = 13$

Now let's compare performance of a this new system –AS/RS and AGVS- with the performance of current practices – block stacking and manual trucks – on the four axis evaluation systems defined earlier. Four key variables were FEUs stored per unit of land, FEU moves per FEUs stored, FEU moves per unit of land, and FEU moves per vehicle. Now define the scale of each axis in a way that the value of the corresponding variable for the current practices is equal to 1. The relative key-variables for the proposed system is shown in figure 11 where improvements of 2 to 6 times are observed on different axes. Since Y+ axis is multiplication of X+ and X- axis, therefore a multiple criteria of Moves / FEUs stored and FEUs stored / Land could be replaced by a single criteria of Moves / Land.

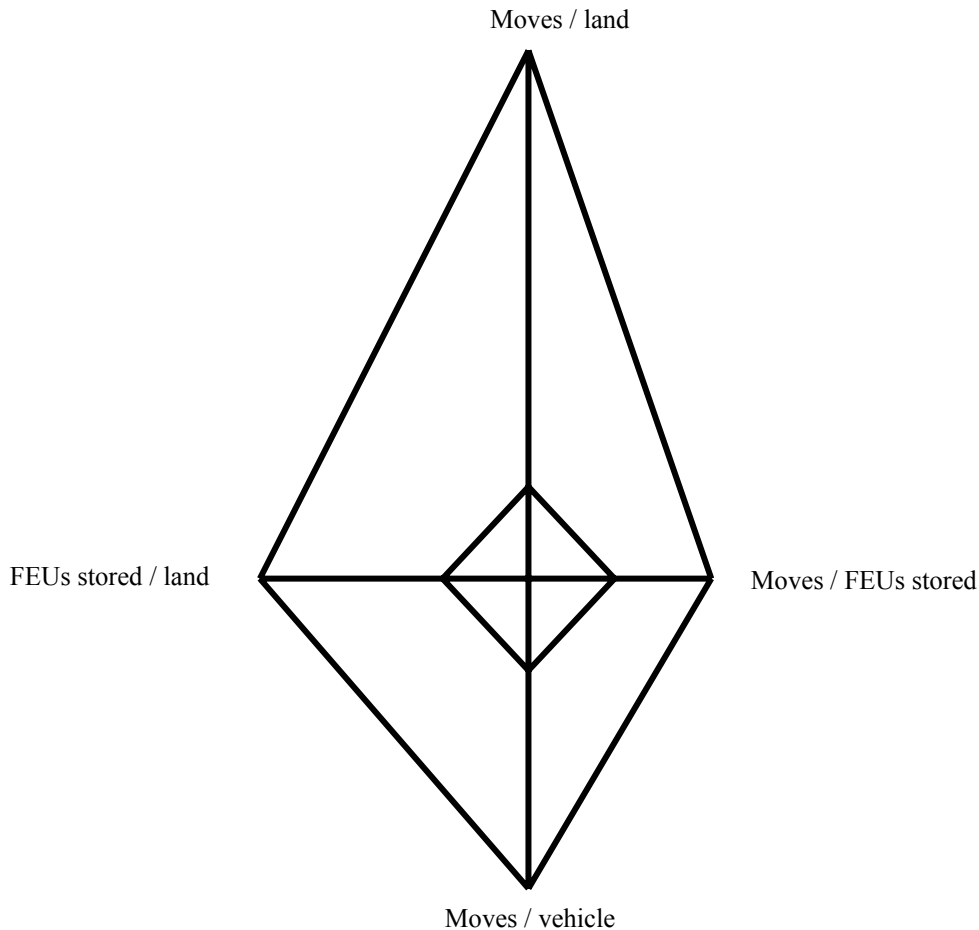

Figure 11. Comparison of the current practices with the proposed system.

In addition, AS/RS offers flexibility, expandability, quality, and reliability, and management control. Flexibility; it can retrieve the desired containers with the desired attributes (content, destination, weight, etc) in the desired sequence. It could have random access for expedited intermodal hand-offs and 24 hour on demand service with ATM card. Expandability; additional modules can be added easily. Quality; the potential of picking wrong containers is minimized. The US standard of 1 error in 100 moves approaches the Japanese standard of 1 error in 10000 moves. Reliability in cycle time; The standard deviation of cycle time of both AS/RS and AGVS are smaller than that of human-operated material handling equipment. Accuracy of retrievals are also higher. Management control; high value containers are well tracked and securely stored.

In general, material handling means providing the right amount of the right material, in the right condition, at the right place, at the right time, in the right position, in the right sequence, by the right method, and for the right cost. It seems that AS/RS dominates present conventional block container layouts in all the above directions except in the initial investment cost. Table II

Table II. Preliminary cost analysis of the AS/RS structure module for 200 FEUs

<i>Material</i>	<i>Amount</i>	<i>Price</i>	<i>Sub Total</i>
Steel (Pounds)	3,619,025	\$1/Pound	\$3,619,025
Concrete (cy)	1,833	\$100/cy	\$183,333
Metal Deck for roofing (sf)	99,000	\$1.25/sf	\$123,750
		Total	\$3,926,108

* This estimation is for a 10 story, 10 , that stores 200 containers.
 * The estimated price is included material, labor, equipment and applicable taxes and insurance.
 * This Price is calculated based on regular job, if the job is a prevailing job the prices will be different (\$1.5/pound for steel, \$200/cy for concrete).
 * For the footing we do not have an estimation. The estimation is based on soil test but excavation and footing price for regular job is \$150/cy and for prevailing job is \$250/cy.
 * If we face water meanwhile excavation the above price will increase to \$400/cy
 * The total area for a one warehouse for 200 containers, is 100,000 sf.
 * The warehouse structures cost \$4,000,000 each, \$20,000/container and \$40/sf.

8. Physical Simulator

Scaled models of the AS/RS system and the AGV have been designed and are being constructed to better demonstrate the feasibility of the concept and to provide a test bed for prototype control software development and overall system evaluation. Figure 12 shows various views of the AS/RS lifting mechanism design. In this design the lifting mechanism can reach any position of either rack on its two sides and grab or drop a container at the target position.

The benefits of the scaled model are the following:

- Proof of concept and demonstration of real-time operation
- Generates mechanical designs that will be useful for the actual system design
- Generates control software that can be directly implemented on the real system
- Sensory system and network will be directly usable in the real system

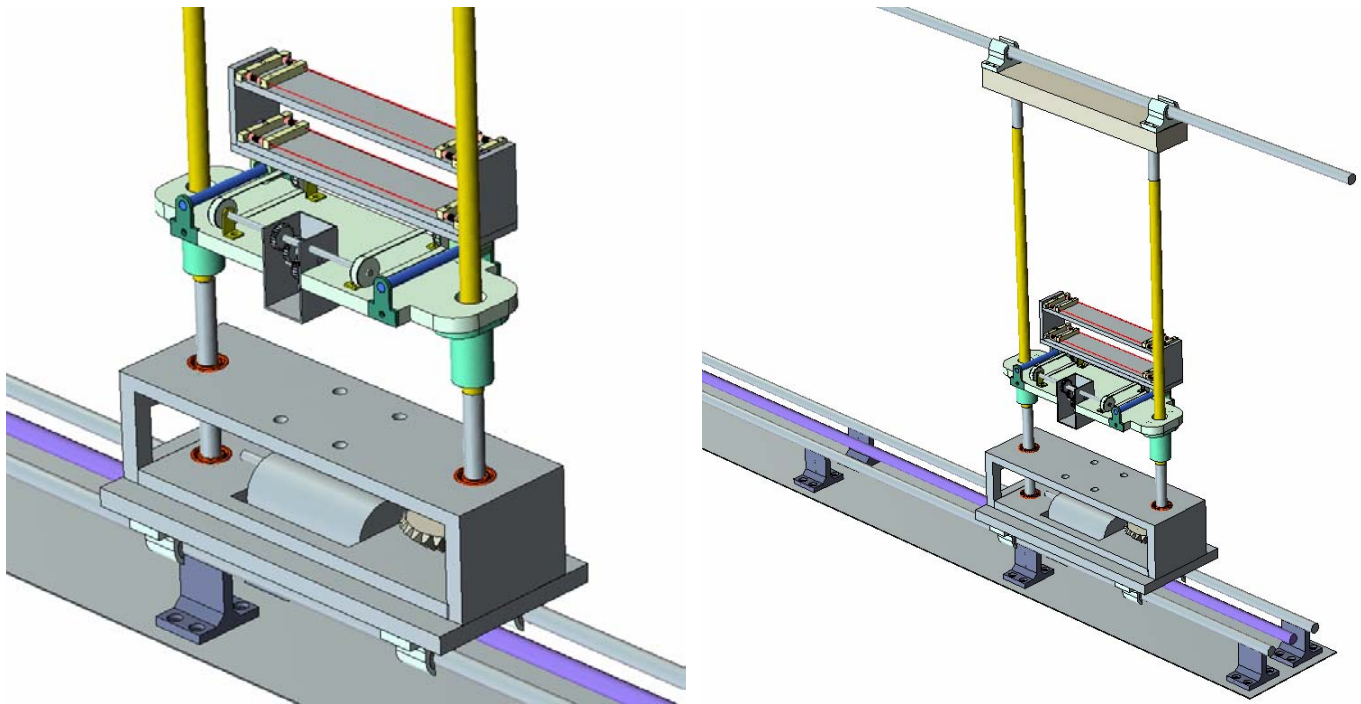

Figure 12. Bi-directional container lift mechanism of the physical simulator

9. Suggested Directions for Future Research

A promising direction for future research is to analyze the impact of changes and improvements in the basic sub-systems of a maritime container terminal on the overall performance of the total system. The sub-systems are mainly AS/RS, Grid on Rail (GR), AGVS, quayside cranes, a JIT inventory control philosophy, the yard transportation network, and the overall layout of the terminal. On the foundation of the present simulation-animation model, we will develop a modeling architecture to be utilized as the test bed to examine many other scenarios in any of the 14 major terminals in the combined Ports of LB and LA. A techno-economic feasibility analysis is conducted regarding the implementation of the proposed integrated system. The concepts and ideas can be extended to other metropolitan transportation systems such as design of in-land intermodal terminals, and automated parking structures and autonomous people movers in downtown of big cities.

Several sub-systems, as described below, may be added to our present simulation model:

AS/RS: There are many issues that could be addressed regarding performance improvement of AS/RS. Perhaps one of the main issues is where to locate idle vehicles. The management of the idle machine is an important control problem that has drawn little

attention. To quickly respond the next pick-up request, during this interval, idle machine may travel to predetermined locations. This is compared with the movement of a goal-keeper who tries to correct his/her position after blocking the ball in anticipation of the returning ball. It is important to decide where to position idle vehicles because these positions determine the response times. The response time of an idle vehicle is the travel time to the next pick-up point.

One other issue is performance and cost analysis of AS/RS when it is directly under the ship cranes and a linear motor system serves as the interface between AS/RS and Ship. The other issue is feasibility and performance analysis of having two AS/RS machines in each AS/RS module. One for interaction with ship, the other for interaction with trucks. Conflict resolution between the two machines is definitely a difficult problem. A more conservative version of this concept is to have one machine, but assigning it to ship for a portion of time, and then switching it to truck. For example, serving the ship side for 2 hours, and then switch to truck side for one hour, and then switch back and forth.

Grid on Rail (GR): A concept referred to as GR by August Design, which can be interpreted as a block stacking approach combined with a semi-AS/RS concept and an AGV type overhead shuttle can be used for ship loading and unloading. While a totally automated AS/RS is suitable for situations in which no specific container arrangement can be predicted, GR may be used for certain scenarios in which all containers for a given ship can be stacked. This possibility eliminates the need for random access of containers for which a fully automated AS/RS is most suitable. GR uses an overhead grid network of rails, and a set of overhead container handling shuttles moving on the network using linear

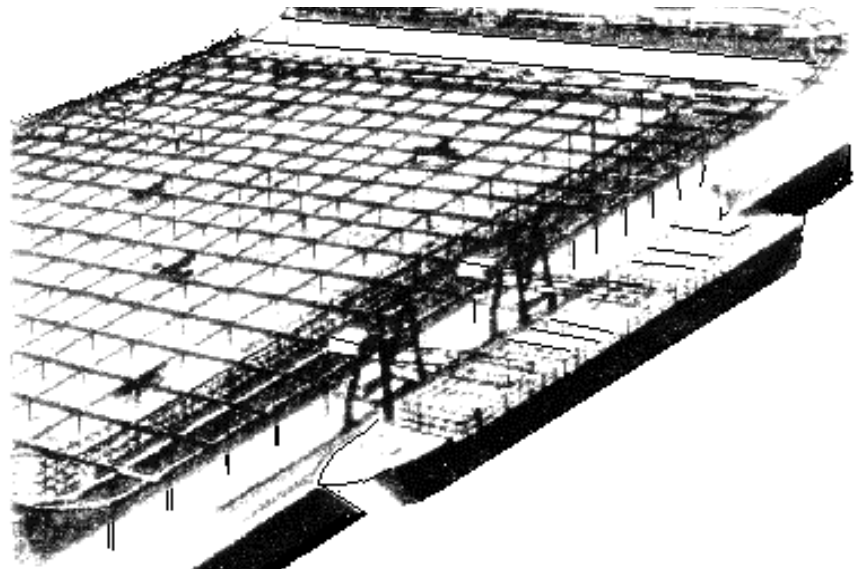

Figure 13. Grid on Rail (GR) conceptualized by August Design

induction motors and passive switches. Containers are staked under the grid system and are retrieved in a pseudo-random pattern. While the system takes advantage of container stacking, the storage and retrieval is faster than the conventional approach, and separate horizontal transportation roads are not needed. This concept is shown in Figure 13. The specifications of the number of rows, columns, modules, and dimensions of a GR system must be configured systematically and the approach should be compared to ours.

AGVS: There are many issues that could be addressed regarding implementation of AGVS container terminals. Following are some of the important items:

- Operational Rules: Design of the appropriate operational rules to minimize the fleet size of AGVs while meeting a specific throughput, or maximizing the throughput using a specific fleet size of AGVs. Of special interest in this regard are
- Dispatching Rules : When an AGV becomes idle and several containers are waiting, to which container it should be dispatched. When several AGVs are idle and a container is waiting, which AGV should be dispatched to it
- Vehicle Routing: If an AGV has to go from point A to point B and there are several routes from A to B, which route is the best route. Obviously, the best route is not necessarily the shortest route.
- Traffic Management: When several vehicles approach an intersection, which vehicle has Right of Way.

The other very important issue that could be addressed, is comparison of AGV without loading / unloading capabilities with AGV with loading / unloading capabilities. An AGV with loading / unloading capability could be some thing like a straddle carrier. A vehicle which keep the container under its structure and slightly lift it up or set it down. With loading / unloading capability, there is no need to a second material handling equipment to load and unload AGVs.

Yard Transportation Network: The current yard transportation network wastes a considerable portion of the available lands in maritime terminals. Furthermore, given the expected increase in the volume of containers handling activities, it could result in substantial blocking and a lower average speed. This is mainly due to an excessive number of vehicles and intersections on a relatively small network. In order to reach the required throughput, and avoid a long response time to incoming road trucks, one needs to invest in more vehicles. However, increasing the number of trucks on such a network could result in still more blocking, the system may never reach its expected throughput. Furthermore, having more acceleration and deceleration results in more energy consumption. In summary, the present complicated yard transportation network requires additional investment in both land and equipment; it may lose its expected throughput, and has higher operating costs due to more energy consumption. To resolve congestion, we propose a simpler network, which is based on a unidirectional loop based pattern. Indeed all three difficulties in dispatching, vehicle routing, and traffic management of operations of the yard-trucks or AGVs will be substantially simplified on a loop flow pattern. Vehicle routing is resolved since there is only one route between each pair of points. Traffic management is resolved since there is no intersection on a loop. Furthermore, simple dispatching rules can be implemented in such a streamlined topology. These features result in less congestion, smaller fleet size, less space requirements for the network, and less operating costs. Our proposed flow network for AGVS in container terminals is a set of loops augmented by a set of short-cut.

Yard Layout: A set of alternative yard layout designs based on alternative dimensions, alternative orientations, and alternative locations of elements will be examined, and the most desirable layout will be suggested.

JIT: An attractive design strategy is to require the incoming trucks to arrive at port as close as to the estimated arrival time of their corresponding ship. A JIT philosophy, reduces both the average inventory and storage area requirements, and the response time to trucks. Furthermore, in a JIT philosophy, direct handling from (to) road trucks to (from) the ship without any type of intermediate storage is also permissible. Note that by direct handling from (to) road trucks to (from) the ship we mean direct movement from truck-site to ship-site via yard truck and by-passing any type of intermediate storage. Under a JIT policy, arrival time of a considerable number of trucks are matched with loading / unloading activities of incoming ships. Therefore, the entire on-yard storage and retrieval process is by-passed. However, due to institutional difficulties, it is not yet possible to allow road trucks to go directly under the ship cranes. This difficulty is resolved by having yard AGVs play the interface role. Furthermore, in a JIT philosophy, few blocks of GR or conventional stacks may be assigned to an incoming ship, which its estimated time of arrival is within 3 days. Those containers which come to the port much in advance of the proposed ship arrival are stored in AS/RS. The others are stored in GR or Stacks, or are left on their chassis in a specific area on the yard dedicated to a specific ship

One other issue that could be addressed under JIT inventory philosophy is comparison of a no-wait system with the present practices. That is to compare a situation where buffer is allowed under ship crane and yard crane, with a no-buffer situation in a perfectly balanced line..

Number of Quayside Cranes per Ship: In the current practices, 3 cranes are implemented per ship. The impact of increasing this number to 4-6 on the throughput of the ship loading / unloading process should be examined.

Yard Layout: A set of alternative yard layout designs based on alternative dimensions, alternative orientations, and alternative locations of elements should be examined to find the most desirable yard layout.

Software integration: A simulation software such as AutoMod may be integrated with an optimization software such as CPLEX, and a flow analysis software such as VisFactory. Integration of these software modules creates the effective environment for design and analysis of transportation and logistics systems.

Optimal Combination of the storage alternatives: Last but not least is the optimal combination of deferent storage technologies for a given terminal. For example, 1-Outbound containers

- ❑ Containers arriving more than one week in advance of Estimated Arrival Time (EAT) of the ship may be stored in AS/RS.
- ❑ Containers arriving less than two days before EAT of the ship may remain on chassis.
- ❑ Other containers may be stored in conventional block stacking.

2-Inbound containers

- ❑ Containers with fuzzy information on arrival time of their trucks (these could be a large portion of inbound containers) may be stored in AS/RS.
- ❑ Containers with firm information on arrival time of their trucks may be stored in block stacking storage.
- ❑ Containers with their truck at gate or arriving next day may remain on the chassis.

Figure 14 illustrated various subsystems within a container terminal. Each of these subsystems and the total system deserve careful analysis and design efforts to arrive at terminals with near-ideal performance.

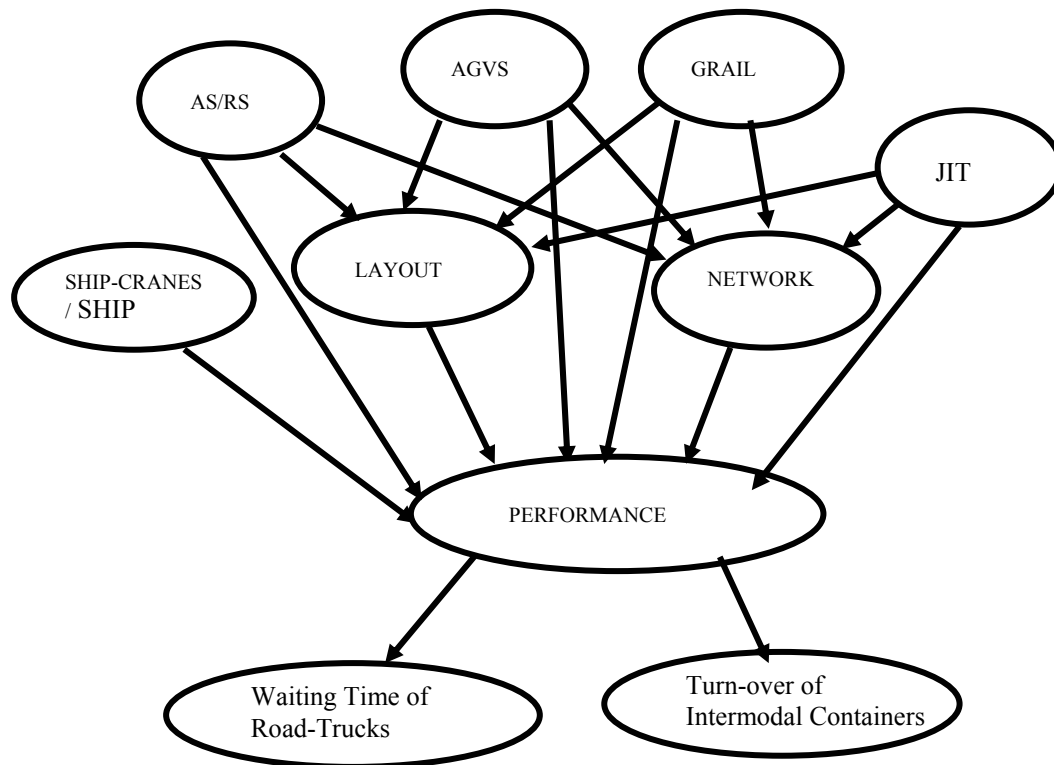

Figure 14. Sub-systems of the total terminal system.

The following additional data will be required (possibly from sources such as Sealand, August Design, VZM...) to make the results of the analysis more realistic, and to make the comparison of the new alternative with Conventional Block Stacking (Random, Dedicated, and On-top), Chassis System (Random, and heuristic policies) a, and GR more meaningful:

- ❑ Distribution of containers arrived x days before ship arrival, for $x= 14, 13, 12, \dots, 2, 1, 0$.
- ❑ The same as above for inbound containers
- ❑ Distribution of container sizes in a typical ship

- ❑ Distribution of capacity of the ships.
- ❑ Distribution of arriving ships with unloading of LT 2K TEUs, 2K-3K TEUs, 3K-4K TEUs,....
- ❑ The same as 3 for loading
- ❑ Percentage of containers with special requirements (refrigerator,
- ❑ Distribution of time between end of loading unloading of one ship and start of loading and unloading of the next ship.
- ❑ Additional data suggested by USC partners
- ❑ Discussion on alternatives for shuttle (i.e. rollers conveyor in the racks and P/D stands, something like a bridge crane for horizontal and vertical movement)
- ❑ What is the feasible number of racks. i.e. which factors restrict the number of bays.
- ❑ What is the feasible number of tiers. i.e. which factors restrict the number of tiers?

9. Conclusion

Through our design and analysis efforts we have demonstrated that container terminal automation is feasible and may have substantial impact on the operations of terminals. The three key-variables of performance assessment, namely throughput, space utilization, and equipment utilization can improve significantly as a result of implementing appropriately selected automation technologies for container handling and storage operations at maritime terminals. Many promising research directions have been identified and presented.

References

- Asef-Vaziri, A, M. Dessouky, and C. Sriskandarajah "A Loop Material Flow System Design for Automated Guided Vehicles" To appear in International Journal of Flexible Manufacturing Systems.
- Asef-Vaziri, A. "Impact of Empty Vehicles on a Circular Flow Path" Working paper, Department of Industrial and Systems Engineering, University of Southern California, 2000.
- Asef-Vaziri, A. and P. Egbelu "A Loop Based Tandem Partitioning for AGVS." Working paper, Department of Industrial and Systems Engineering, University of Southern California, 2000.
- Asef-Vaziri, A. B. Khoshnevis "AS/RS in Maritime Container Terminal", Proceeding of the 6th International Colloquium on Material Handling Research, May 2000.
- Asef-Vaziri, A. G. Laporte, and C. Sriskandarajah "The Block Layout Single Loop Design Problem" To appear in IIE Transactions.
- Asef-Vaziri "A Non-simulation approach to Estimate the Number of Yard-Trucks in a Container Terminal" Working paper, Department of Industrial and Systems Engineering, University of Southern California, 2000.
- AutoMod, User's Guide, 1996, AutoSimulation.
- August Design, GRAIL Report, 1999.
- Johnson, M. E. and M. L. Brandeau "Stochastic Modeling for Automated Material Handling System Design and Control", Transportation science, 1996.
- Khoshnevis, B. "Discrete Systems Simulation", McGraw-Hill, Inc., 1994.
- Khoshnevis, B. and A. Asef-Vaziri "Automation of Container Handling and Storage at Ports - Novel Designs and Simulation Studies, 4th International Conference on Coasts, Ports, and Marine Structures, Bandar Abbas, November 2000.
- Khoshnevis, B. and A. S. Kiran, "An FMS Physical Simulator," Journal of Manufacturing Systems, 1986.
- Khoshnevis, B. and R. Rogers, "An Automated Warehouse Simulator System," Proceedings of the Fifth International Conference on Automation in Warehousing, Atlanta, Georgia, 1983.

- Ratliff, H.D. and P.M. Griffin, “ Storage Strategies for Containerized Cargo Ports” *Port Technology International*, Vol. 7, 1999.
- Tompkins, J.A., J. A. White, Y. A. Bozer; E. H. Frazelle, J. M. A. Tanchoco, J. Trevino, *Facilities Planning*, 1996, John Wiley & Sons.